

CP 970

Short Travel and Battery Probes $\geq 3,00$ mm / ≥ 118 mil

Available Tip Styles

Material	Tip Style	ϕ mm
B	D 	1,30

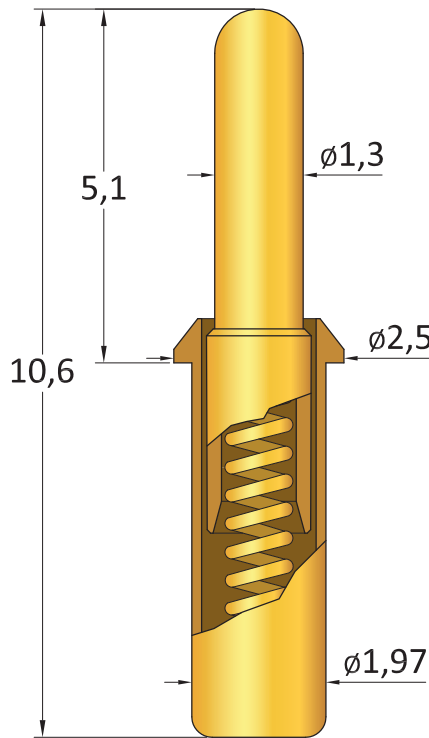

Technical Data

Recommended minimum centers:	3,00 mm
Recommended working stroke:	2,80 mm
Maximum stroke:	3,30 mm
Current rating:	5,0 - 8,0 A
Typical contact resistance:	<20 m Ω
Operating temperature range:	-50° up to +100°

Materials

Plunger:	BeCu, nickel or gold plated
Barrel:	Brass, gold plated
Spring:	Music wire, gold plated
Receptacle:	Brass, gold plated

Spring Force (g $\pm 20\%$)

Spring force:	200 g
Alternative:	120 g

Hole size without receptacle

Drills: $\phi 1,96 - \phi 1,98$

Hole size with receptacle

Drills: $\phi 2,28 - \phi 2,29$

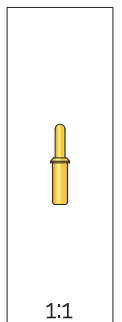
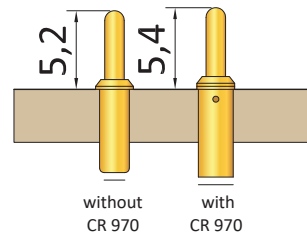
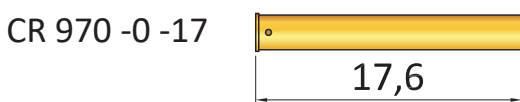
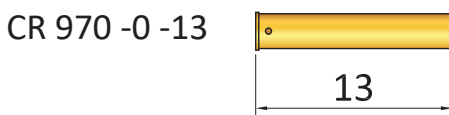
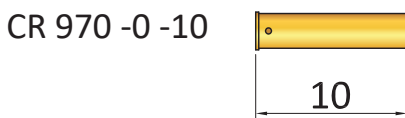
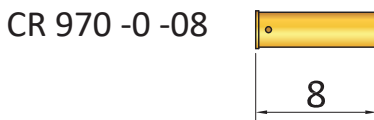
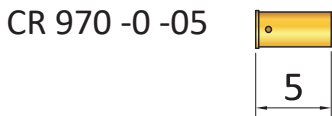
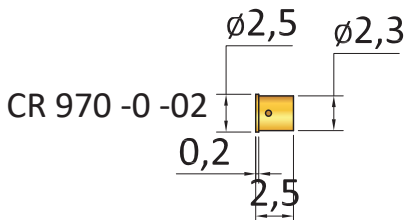

Ordering example:

Series	Tip ϕ mm	Spring Force	Material	Plating
CP 970	D	102	B	G
	Tip Style		B=BeCu	G=Gold N=Nickel