



Basic Contact Probes

F10006B150G225

Order code 1096449

General

Design	Basic Contact Probe
Family	F100
Pitch [mm/mil]	2.54 / 100
Temperature [C°]	-45°C...+80°C

Electrical specifications

Continuous current [A]	5.00
Typical contact resistance [mOhm]	20.00

Mechanical specifications

Preload [cN]	90.00
Spring force [cN]	225.00
Nominal travel [mm]	4.30
Maximum travel [mm]	6.40
Pointing accuracy +/- [mm]	0.08

Dimensions

Total length [mm]	33.30
Projection height [mm]	8.40
Tip style diameter [mm]	1.50
Barrel diameter [mm]	1.37

Materials & surfaces

Tip style	06
Plunger material	Beryllium copper
Plunger plating	Gold
Barrel material	Bronze
Barrel plating	Gold
Spring material	Spring steel
Spring plating	Silver

Family drawing

All measurements are in mm.

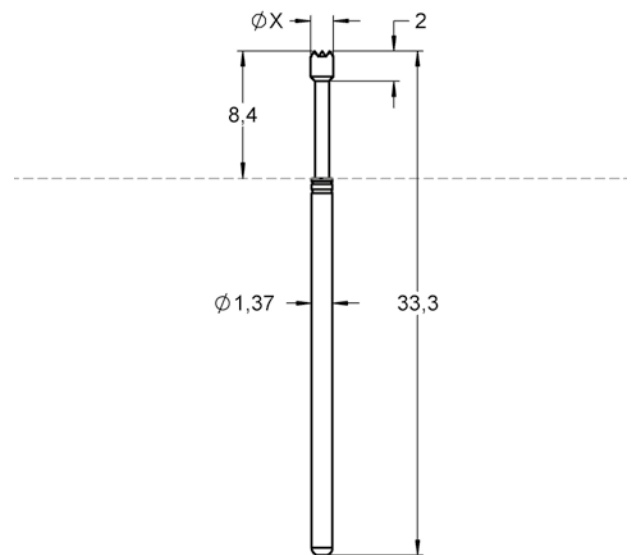

Accessories

Tool for receptacle	FEWZ-100EV
Tool for probe	1003566-FDWZ-100
Other	1010816-H100LA-2.0, 1097191-H100CR-7.6S1, 1133588-H100WW19-10.0AT, 1107897-H100WW10-2.5S1, 1100025-H100WW05-7.6S1

Tip style 1

