

# F075HP

Up to 4 A | 75 mil | ICT application



### Electrical specifications

Current [A]	4
R <sub>TYP</sub> [mOhm]	<40

### Mechanical specifications

Temperature [°C]	-45°...+100°		
Preload [cN]	70	120	130
Spring force [cN] at nt ±20%	130	200	250
Nominal travel [mm]	4.3	4.3	4.3
Maximum travel [mm]	6.4	6.4	6.4

### Materials and plating

Plunger	Palladium alloy	unplated
Barrel	Nickel silver	gold plated
Spring	Spring steel	silver plated
Receptacle	Nickel silver	gold plated

### Accessories

1010808	H075LA-7.6	Receptacle
1008325	FEWZ-075EV	Insertion tool receptacle
1003587	FDWZ-075	Insertion tool probe

\* Overview of other receptacles H075 on page 52+53

### Drill size recommendation (mm)

H075...	Press ring as stop	1.29 - 1.30
H075...	Press ring inserted	1.36 - 1.40





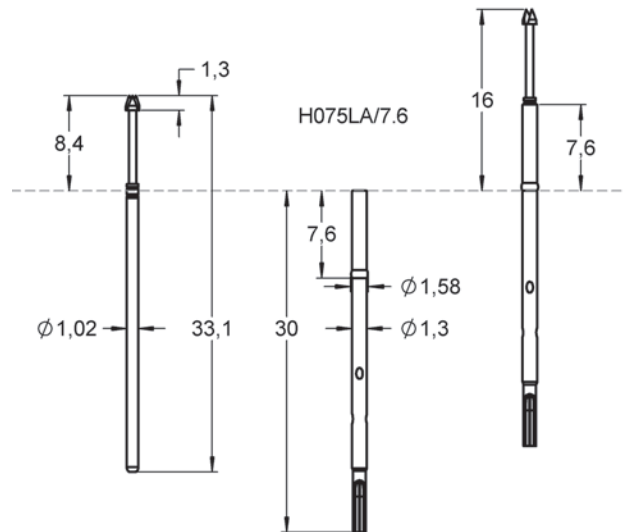















### Series drawing

All measurements are in mm.



Order code	Product name	Tip Style	Tip Ø [mm]	Material/Plating	Force [cN]	Thread [M]	Version	FM Choice
1030563	F07514S120P250HP	14	1.20	S / P	250	-	HP	
1010210	F07521S064P200HP	21	0.64	S / P	200	-	HP	
1010169	F07521S064P250HP	21	0.64	S / P	250	-	HP	

# BASIC PROBES 75 MIL

Order code	Product name	Tip Style	Tip Ø [mm]	Material/Plating	Force [cN]	Thread [M]	Version	FM Choice
1014301	F07532S064P250HP	32 	1.20	S / P	250	-	HP	-
1016294	F07533S064P130HP	33 	0.64	S / P	130	-	HP	
1010209	F07533S064P200HP	33 	0.64	S / P	200	-	HP	
1010077	F07533S064P250HP	33 	0.64	S / P	250	-	HP	
1033612	F07535S120P250HP	35 	1.20	S / P	250	-	HP	-
1038209	F07535S120P200HP	35 	1.20	S / P	200	-	HP	-
1135611	F07537B050P200HP	37 	0.50	S / P	200	-	HP	-
1010388	F07543S064P130HP	43 	0.64	S / P	130	-	HP	
1010211	F07543S064P200HP	43 	0.64	S / P	200	-	HP	-
1010170	F07543S064P250HP	43 	0.64	S / P	250	-	HP	
1145256	F07543S064P300HP	43 	0.64	S / P	300	-	HP	
1010212	F07562S064P200HP	62 	0.64	S / P	200	-	HP	
1010171	F07562S064P250HP	62 	0.64	S / P	250	-	HP	